

SEM1605/P USER GUIDE

SMART DIN RAIL MOUNTED TRANSMITTER INPUT PT100
 TWO WIRE 4 to 20mA

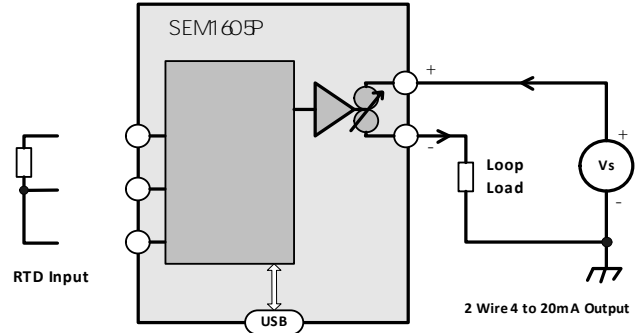

Important - Please read this document before any installing.



Every effort has been taken to ensure the accuracy of this document, however we do not accept responsibility for damage, injury, loss or expense resulting from errors and omissions, and we reserve the right of amendment without notice.



IMPORTANT - CE & SAFETY REQUIREMENTS

Product must be mounted inside a suitable enclosure providing environmental protection to IP65 or greater.

To maintain CE EMC requirements, input wires must be less than 3 meters.

The product contains no serviceable parts, or internal adjustments. No attempt must be made to repair this product. Faulty units must be returned to supplier for repair.

This product must be installed by a qualified person. All electrical wiring must be carried out in accordance with the appropriate regulations for the place of installation.

Before attempting any electrical connection work, please ensure all supplies are switched off.

ABSOLUTE MAXIMUM CONDITIONS (To exceed may cause damage to the unit) :-

Supply Voltage	± 30VDC (Protected for over voltage and reverse connection)
Current with over voltage	± 100mA
Input Voltage	± 3V between any terminals
Ambient	Temperature (-30 to 70) °C Humidity (10 to 95) % RH (Non condensing)

PRODUCT SPECIFICATION

Please refer to the product data sheet for full specification, available to download at www.status.co.uk.

RECEIVE AND UNPACKING

Please inspect the packaging and instrument thoroughly for any signs of transit damage. If the instrument has been damaged, please notify your supplier immediately.

CONFIGURATION



IMPORTANT - The SEM1605P can be configured while connected and powered, but a portable battery powered computer must be used to avoid the effects of ground loops.

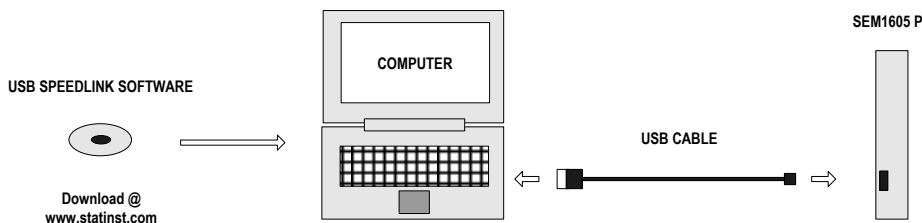

The following parameter can be configured by simply entering as prompted by the software package.

- RTD INPUT TYPE (Pt100, Ni100, Ni120, CU53, CU100)
- Low range
- High range
- Units (°C, °F)
- Burnout (direction of output current on sensor burnout)

Factory default:

RTD	= Pt100
IEC	= 003851
Low Range	= 0
High Range	= 100
Units	= °C
Burnout	= UPSCALE

MECHANICAL INSTALLATION

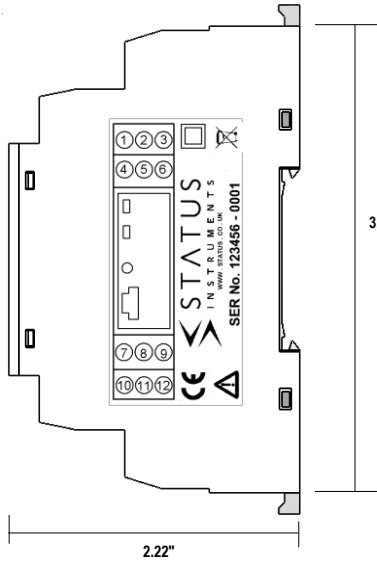

MOUNTING

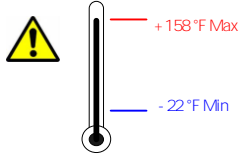
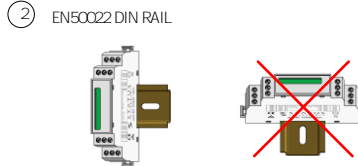
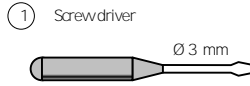

SEM1605P Enclosure

Style	DIN 43880 (1 module width)
Material	Polyamide 6.6 self extinguishing
Terminals	Screw terminal
Cable	2.5 mm Max
Color	Gray

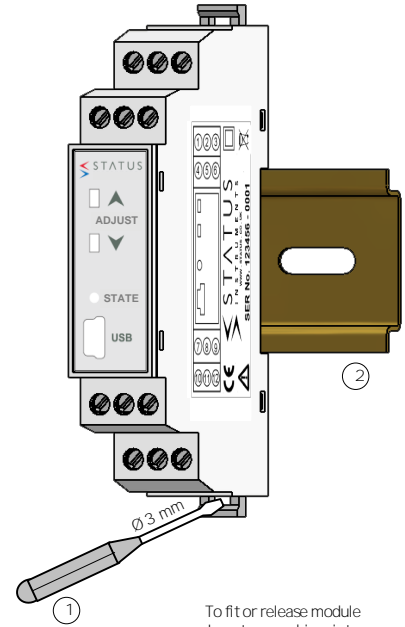

To fit or release module
Insert screwdriver into
slot and lever latch
away from body

ELECTRICAL INSTALLATION

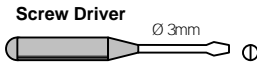
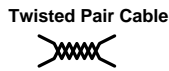
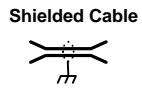

TURN OFF SUPPLY BEFORE WORKING ON ANY ELECTRICAL CONNECTION

INPUT CONNECTION

RTD wire must be equal length and type.
To maintain CE compliance cable length must be less than 3 Meters.

OUTPUT CONNECTION

Use twisted pair or shielded cables for cable lengths greater than 30 Meters. Max cable length 1,000 Meters. Ensure loop is grounded at one point.

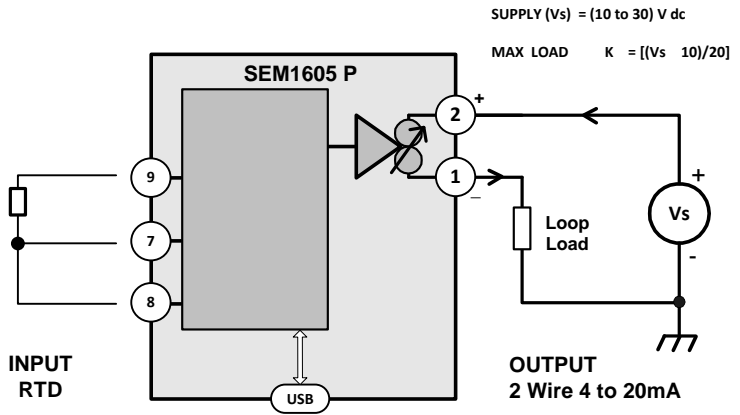

Button Configuration options.

The SEM1605P has three options selectable in the USB Speed Link software, Trim, Range and off

USER ADJUST

Screw Driver

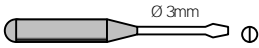

Digital mA meter

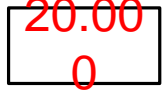

Power supply 10 to 30VDC

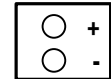

Resistor Decade box

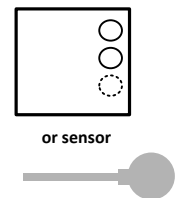

User adjust function allows manual adjustment of the output current, this is useful for minor calibration adjustment or trimming out any sensor error, $\pm 5\%$ of range adjustment is available at both offset and span. Raise and lower buttons are provided on the front panel of the transmitter, accessed using a 3mm flat blade screw driver. Insert the screw driver into the appropriate slot to operate the button. The button has a click action.

The transmitter will automatically detect the correct adjust point (offset or span) based on the output current drive. Offset will be adjusted when the current is between 3.8 to 6mA, span when the current is between 18 to 22mA. No trim action occurs at any other current.

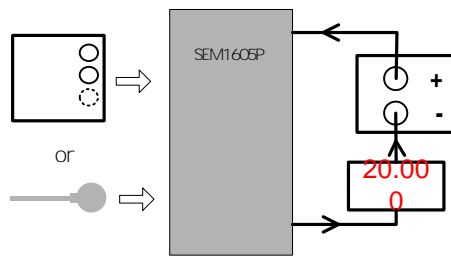
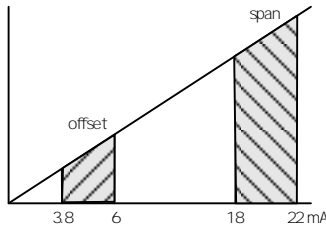

METHOD

1.0 Connect transmitter to a suitable Resistor decade box or sensor. Connect output to a DC supply, connecting a digital mA current meter in series with the output. Turn supply on, set input to either offset or span calibration point.

2.0 Adjust output current by pressing either the raise or lower button, single click to step advance, or press continuously to auto advance.

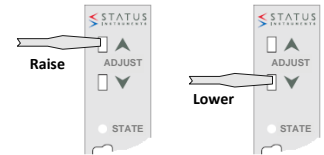

3.0 Once adjust is complete allow 30 seconds with no button press, the transmitter will time out and return to normal operation.

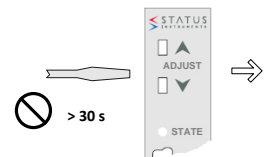

USER RANGE

Screw Driver

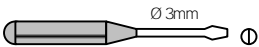

Power supply 10 to 30VDC

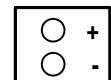

Resistor Decade box

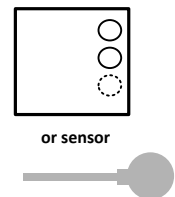

User range function allows manual adjustment of the 4mA and 20mA output range in relation to the input value.

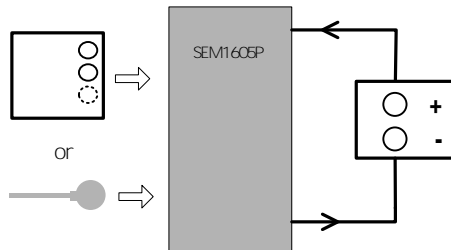

Method

1.0 Connect the resistor decade box or the input sensor to the SEM1605P using the three connection terminals. Connect the SEM1605P to a 10 to 30VDC power supply, a digital ammeter connected in series with the SEM1605P will be useful to monitor the 4 to 20mA current but is not essential. Turn on the supply and allow 1 minute warm up period.

2.0 Set the resistance decade box to the equivalent resistance of the sensor for the required low range temperature, or apply required low range temperature to the sensor. Allow 10 seconds for the SEM1605P to settle.

3.0 Press and hold the Low range ADJUST button, marked with a blue down arrow, until the STATE LED starts to flash, then release the button.

Press and release the Low range ADJUST button again, the STATE LED will flash quickly for a short time and the new low range will be stored. The output current will go to 4.0mA.

4.0 Set the resistance decade box to the equivalent resistance of the sensor for the required high range temperature, or apply required high range temperature to the sensor. Allow 10 seconds for the SEM1605P to settle.

5.0 Press and hold the High range ADJUST button, marked with a Red up arrow, until the STATE LED starts to flash, then release the button.

Press and release the High range ADJUST button again, the STATE LED will flash quickly for a short time and the new high range will be stored. The output current will go to 20.0mA. The ranging of the SEM1605P is now complete.

OFF

Pressing the button has no action.

Note:- The Low and High user adjust can be set individually and in any order as required.