

MECHANICAL INSTALLATION

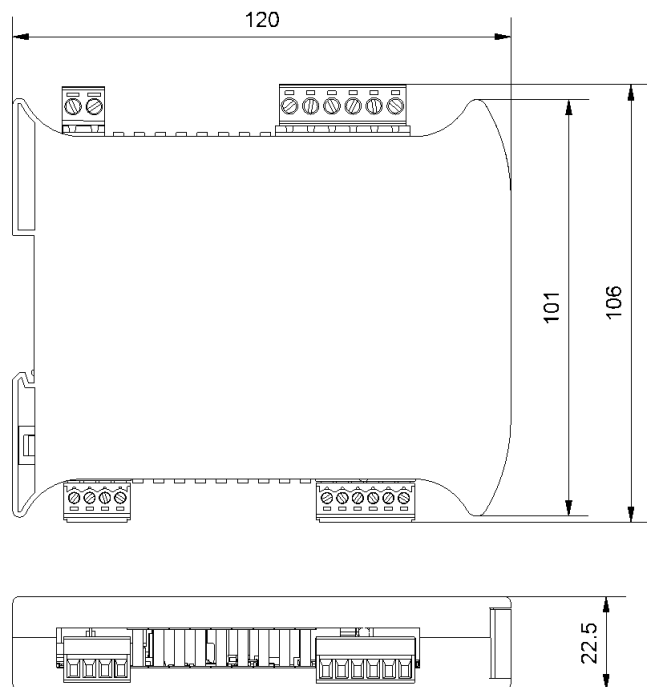

MOUNTING

- ① Screw driver Ø 3 mm
- ② EN60715 DIN RAIL

Enclosure

Style: DIN Rail Mount
 Material: Blend PC/ABS self extinguishing
 Terminals: Screw terminal
 Cable: 2.5 mm Max
 Colour: Gray

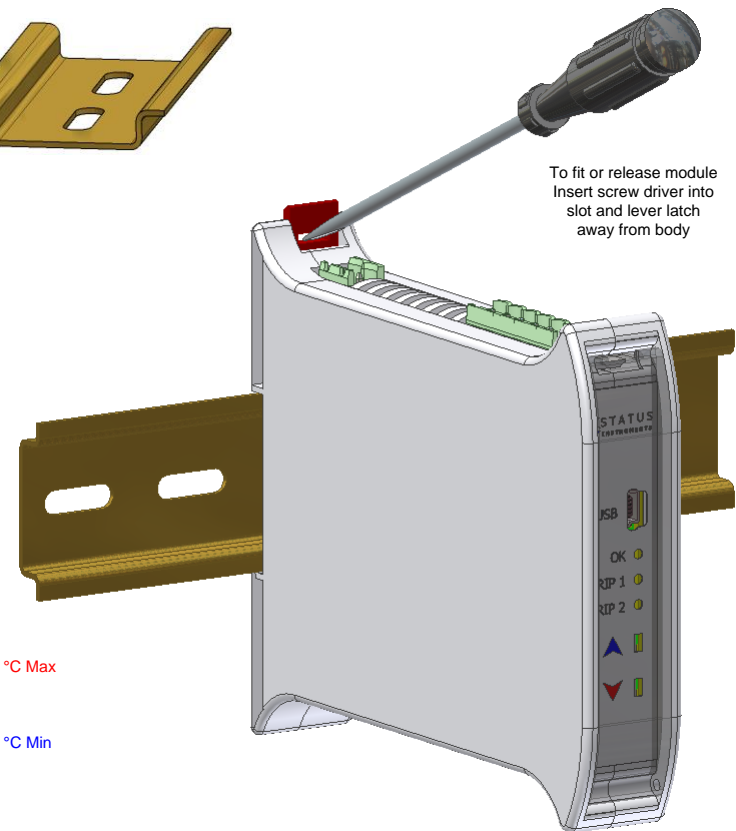

All Dimensions in mm

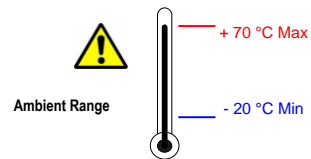

ELECTRICAL INSTALLATION

TURN OFF SUPPLY BEFORE WORKING ON ANY ELECTRICAL CONNECTION

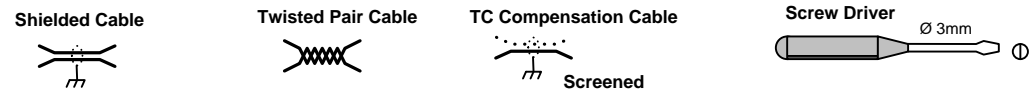

INPUT CONNECTION
 For cable length < 3 Meters no shielded cable or twist pair required.
 Thermocouple inputs must use correct compensation cable.
 Pt100 inputs all three wires must be equal length (resistance).
 Max input cable length 30 meters.

ANALOG OUTPUT CONNECTION
 For cable length < 3 meters no shielded cable or twisted pair required.
 Use twisted pair or shielded cable for current output < (30 to 1000) meters.
 Voltage output use shielded cables (3 to 30) meters, cable lengths > 30 meters not advised.

TRIP OUTPUT CONNECTION
 Trip outputs are isolated from each other.
 Max switching current 1 A @ 240 V ac, 1 A @ 30 V dc

SUPPLY CONNECTION
 Supply input is not polarity sensitive.
 Max supply 240 V ac or 240 V dc

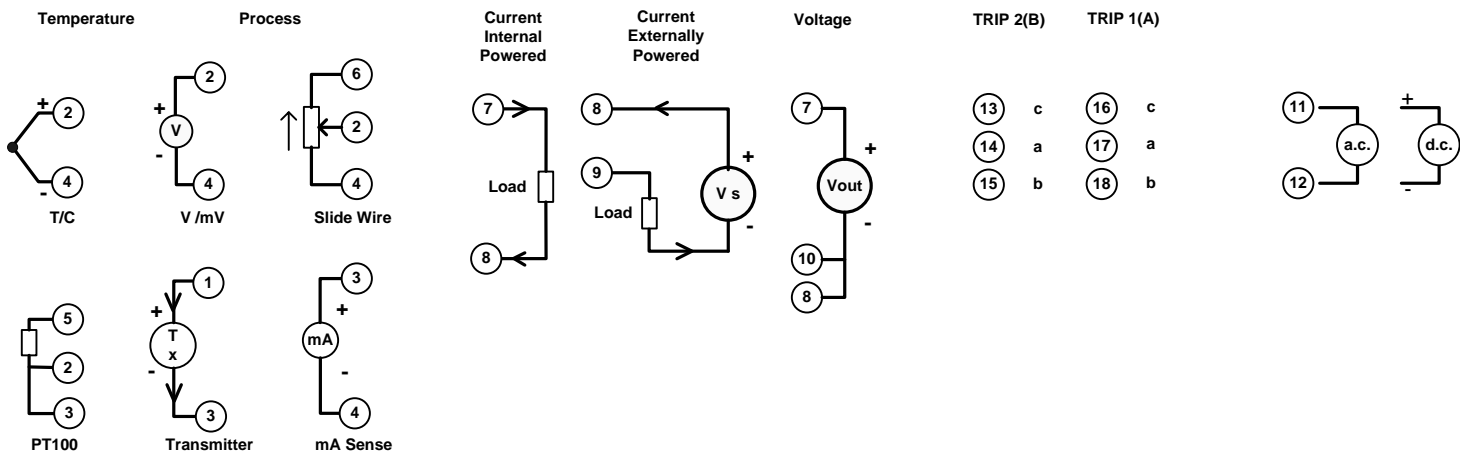

SEM1700 USER GUIDE

Temperature/Process Conditioner with Universal input, outputs supply plus manual config/trim.



Important - Please read this document before any installing.

Every effort has been taken to ensure the accuracy of this document, however we do not accept responsibility for damage, injury, loss or expense resulting from errors and omissions, and we reserve the right of amendment without notice.

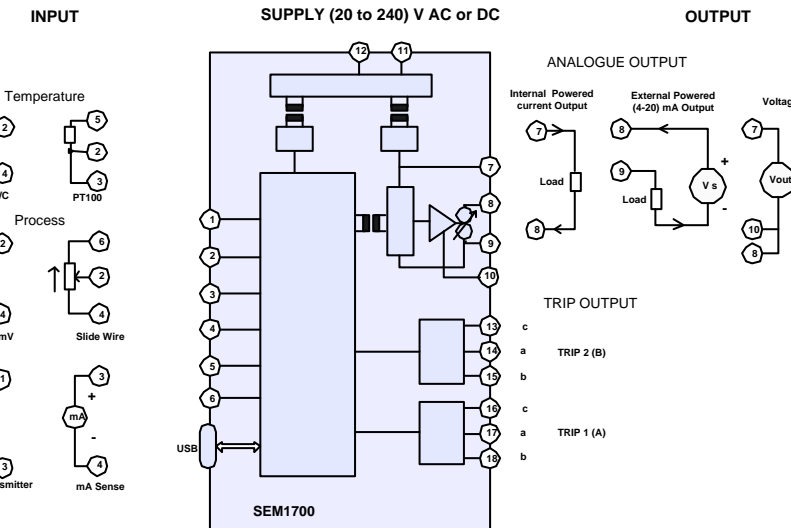

IMPORTANT - CE & SAFETY REQUIREMENTS

This product is suitable for environment Installation category II pollution degree. The product is classed as "PERMANENTLY CONNECTED EQUIPMENT". Product must be DIN rail mounted, inside a suitable enclosure providing environmental protection to IP65 or greater. DC supply must be derived from a local supply and not a distribution system. Max relay contact rating 240 V AC @ 1 a (30 V DC @ 1A). Any circuit connected to a contact must be fused with a 2 A (T) fuse. To maintain CE EMC requirements , input and supply wires must be less than 30 meters. The product contains no serviceable parts , or internal adjustments. no attempt must be made to repair this product. Faulty units must be returned to supplier for repair. This product must be installed by a qualified person. All electrical wiring must be carried out in accordance with the appropriate regulations for the place of installation. Before attempting any electrical connection work, please ensure all supplies are switched off.

ABSOLUTE MAXIMUM CONDITIONS:-

Supply Voltage	± 240 V dc ± 240 V ac (Protected for over voltage)
Input Voltage	± 24 V between any terminals
Input Current	± 50 mA between terminals
Output	30 V dc
Trips	240V ac @ 1A 30V dc @ 1A non inductive
Ambient	Temperature (-4 to 158) °F Humidity (10 to 95) % RH (Non condensing)

PRODUCT SPECIFICATION

Please refer to the product data sheet for full specification, available to download at www.status.co.uk.

RECEIVE AND UNPACKING

Please inspect the packaging and instrument thoroughly for any signs of transit damage. If the instrument has been damaged, please notify your supplier immediately.

CONFIGURATION

IMPORTANT During configuration the device takes its power from the USB port, therefore no power connection is required. The device can be configured while powered but the computer used must be isolated from the mains supply earth to avoid ground loop effects.

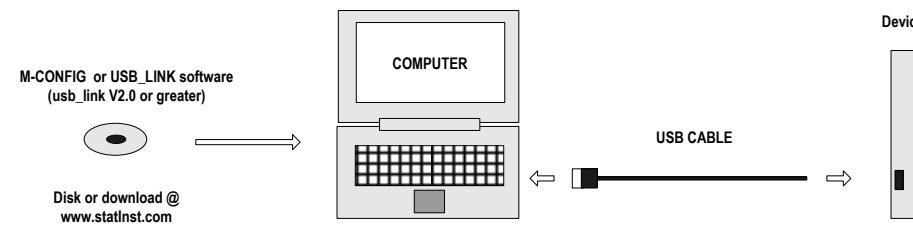

The following parameter can be configured by simply entering as prompted by the software package.

- Input type / input sensor / units (temperature inputs) / sample rate
- Scale input to process variable (process inputs only)
- Analog Output / Set Type voltage or current / scale output signal range / scale output to process
- Set adjustable damping for both rising and falling output. Set correction for voltage output load.
- Trip Outputs / Set action / Set setpoints / Set deadband / Set adjustable delay on and delay off
- Set burnout direction on sensor failure or input overrange.
- Set the function of the front panel user buttons to off, trim or configure.
- TAG number

Factory default:
 Input type = P
 Sample rate = 1000 mS
 Units = °C
 Output = (4 to 20) mA damping 0
 High Range = 100
 Low Range = 0
 Burnout = UPSCALE
 User Trim = off
 Trips = off, delays 0
 Damping = 0

USER TRIM

User trim function allows manual adjustment of the analog output, this is useful for minor calibration adjustment or trimming out any sensor error, $\pm 5\%$ of range adjustment is available at both offset and span. Raise and lower buttons are provided on the front panel of the transmitter, accessed using a 3 mm flat blade screw driver. Insert the screw driver into the appropriate slot to operate the button. The button has a click action.

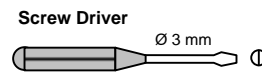

Digital mA meter



Supply

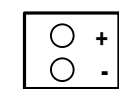

Input Simulator

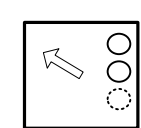

or sensor



The transmitter will automatically detect the correct trim point (offset or span) based on the output signal. Offset will be trimmed when the current in the offset band, span when the current is in the span band. No trim action occurs at any other current. Note this function needs to be selected by the software configuration tool before use. To lock settings after adjustment the operator can again use the tool to turn this function off, (select the option to save trim when downloading configuration).

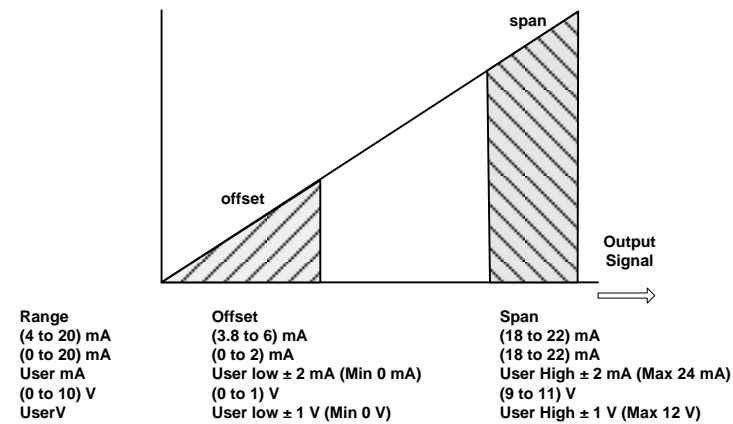

METHOD

1.0 Connect transmitter to a suitable input simulator or sensor. Connect supply, connecting a digital meter to monitor output. Turn supply on, set input to offset/span calibration point.

IMPORTANT - IF PERFORMING TWO POINT CAL. ALWAYS CAL OFFSET FIRST.

2.0 Enter trim menu by pressing "raise" button for two seconds. When the trim menu is open the range LED will flash :-

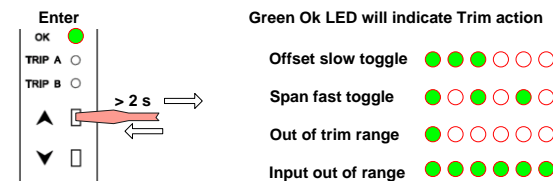

3.0 Trim output current by pressing either the raise or lower button, single click to step advance, or press continuously to auto advance.

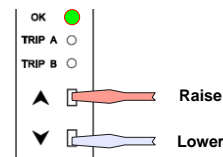

4.0 Once trim is complete allow 30 seconds with no button press, the transmitter will time out and return to normal operation.

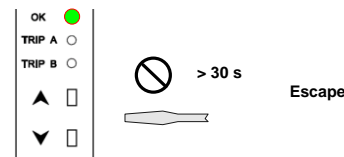

USER RANGE CONFIGURATION

This function allows two point manual configuration of the re-transmission current (voltage) at low and high range against a live input signal. This is useful for on-site configuration, example with a slide wire input the user manually position the slide at both low and high position and configures the unit to operate over this range. Configuration is achieved using either the raise (span) or lower (offset) buttons.

To operate this function it must first be selected using the software configuration tool. The operator may lock this function (once set) by turning off the function.

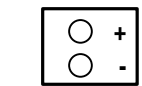
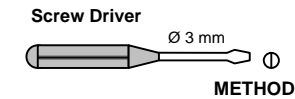

Input Simulator

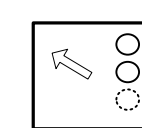

or sensor



METHOD

1.0 Connect transmitter to a suitable input simulator or sensor. Connect supply, turn supply on, set input to either offset or span calibration point.

2.0 To enter configuration, set input to desired high or low setting and wait 10 seconds. Press and hold raise(high) or lower(low) button on for 2 seconds to enter.

The Ok LED will then start to flash at a slow rate (low) or fast rate (high).

3.0 Once the menu has been entered, quickly (within 1 second) apply a single press the the raise(high) lower(low) button to store setting.

To abort configuration, allow configuration to time out by not pressing buttons for 5 seconds.

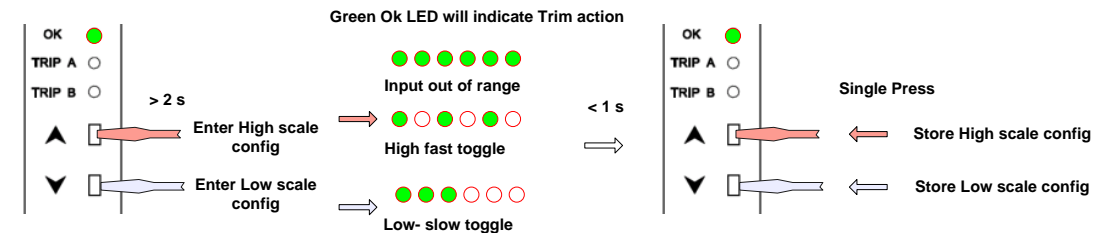

OUTPUT DAMPING

User adjustable damping of the analog output is provided for both rising and falling signal. The adjustable range is (0 to 250) second for a (0 to 20) mA or (0 to 10) V swing. To calculate rate of change of output signal divide 20mA (10 V) by damping setting, example if damping is set to 100 seconds the mA output will change at a rate of $(20/100) = 0.2$ mA /Second. Use USB_LINK software to configure damping setting.

TRIP OUTPUTS

Dual trip SPDT relays are available. The contacts are rated at 240 V ac 1 A (Non inductive) 30 V DC 1 A. An external snubber network is recommended when switching inductive circuits. Please ensure the snubber network is rated for the application. Four actions are provided, as detailed in the diagram below. The Alarm actions may also be used for inverted control applications, example the high alarm action can be used to control a cooling fan when used to control the temperature of a heat source. Ajustable setpoint and deadband are provided together with adjustable on and off delays for each trip. The delay range is (0 to 250) Seconds.

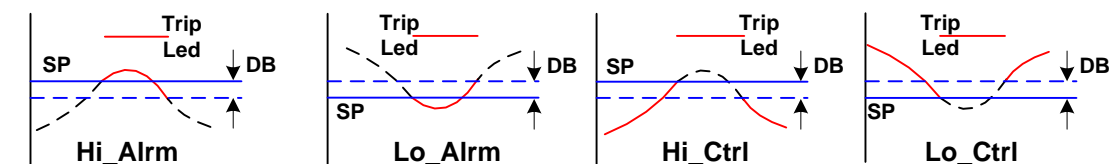

Action	Normal	Trip	Range Error	Power off
Hi_AI Lo_AI	A ○ B ○	A ○ B ○	A ○ B ○	A ○ B ○
Hi_Con Lo_Con	A ○ B ○	A ○ B ○	A ○ B ○	A ○ B ○

