

LOOP POWERED LED INDICATORS



DM700 I and DM720

- PUSH BUTTON PROGRAMMING (NO REFERENCE SIGNAL REQUIRED)
- LOOP POWERED
- 4 DIGIT LED DISPLAY
- LOCAL TRANSMITTER DISPLAY (Pressure, Level, Flow, Temperature, RH, etc.)
- HART TRANSPARENT
- PUSH BUTTON USER TRIM



INTRODUCTION

The **DM700 I Cap** is a two wire current loop indicator that is powered by the 4 to 20 mA DC process signal it is displaying. The face of the Cap houses a 4 digit red LED display. The back contains the screw terminal connections and three push buttons used to program and calibrate the unit by means of a simple menu. The menu allows the user to select units, input/output scaling, offset, decimal point position, and password protection. The DM700 I contains several linearizations which can be applied to display: square root, x 3/2, x 5/2 or a user defined 19 segment linearization curve. The entire DM700 I is sealed in a Cap that fits directly into the SCH Series of NEMA 4X and Explosion Proof housings. Housings have provisions for including temperature transmitters.

SPECIFICATION @ 68°F

GENERAL

Display	4 Red Digit LED
Range	-1999 to 9999 Decimal Point Selectable in any position.
Ambient	-4 to 167°F
I.S. Approval	ATEX II 1G EEx ia IIC (optional)
Ambient Storage	-58 to 185°F
Ambient Humidity	10 to 90% RH
EMC Emissions	BS EN61326
EMC Immunity	BS EN61326
Input	4 to 20 mA Input
Linearization	Linear, Square Root, Power 3/2, Power 5/2, User Defined
User Characteristic	Up to 20 pairs by straight line Interpolation.
Accuracy	± 0.02% FS
HART Transparent	Yes
Power	Loop Powered
Loop Drop	< 4.0 VDC @ 20 mA
Approvals	BS EN 61326

MECHANICAL

Connections	Screw Terminals
Maximum Wire Size	16 AWG Maximum
Environmental Rating	NEMA 4 when in appropriate Enclosure
Material	ABS

INTRODUCTION

The **DM720** is a compact panel mounted loop powered indicator that is designed to connect in series with a 4 to 20 mA current loop and display the value in engineering units. The DM720 is housed in a 48mm x 24mm DIN standard panel mount case and provides 10mm high LED digits. The engineering range is programmed by using easily accessible push buttons. The design of the product means no external power supply is needed and it requires less than 5VDC from the current loop.

SPECIFICATION @ 73°F

GENERAL

Display	4 Red Digit LED
Range	-1999 to 9999 Decimal Point Selectable in any position.
Resolution	16 bits
Conversion Rate	62 / second
Reading Rate	2 / second
Ambient	14 to 140°F
Ambient Storage	-13 to 185°F
Ambient Humidity	< 95% RH at 105°F
Input	4 to 20 mA Input
Resolution	0.01 mA
Input Impedance	10 Ω
Accuracy	± 0.1% of rdg +3 digits
Temperature Coefficient	60 ppm / °F
Warm Up	5 minutes
Power	Loop Powered
Loop Drop	<5.0 VDC @ 20 mA
Approvals	EMC 89/336/CEE

MECHANICAL

Connections	Screw Terminals
Maximum Wire Size	16 AWG Maximum
Environmental Rating	NEMA 4 Front Panel
Dimensions	1.89" w X 0.945" h X 1.57" d
Panel Cutout	1.77" w X 0.876" h
Weight	0.11 pounds
Maximum Altitude	6,500 feet
Case Material	Polycarbonate s /UL 94 V-0

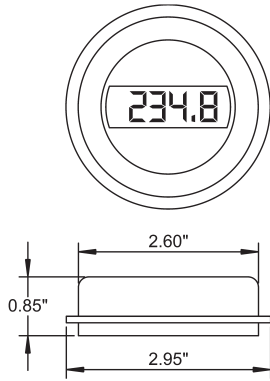

DM700 I

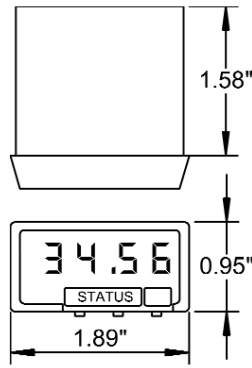

DM720

METAL HOUSINGS FOR DM700 I LOOP POWERED LED INDICATOR

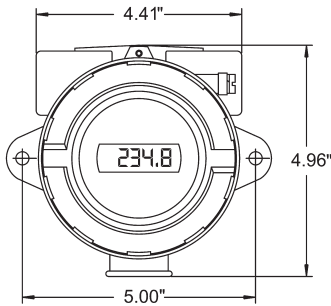

SCH18

ALUMINUM EXPLOSION PROOF HOUSING

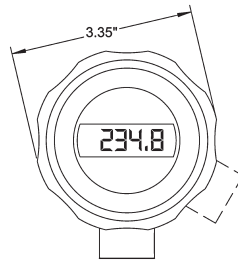
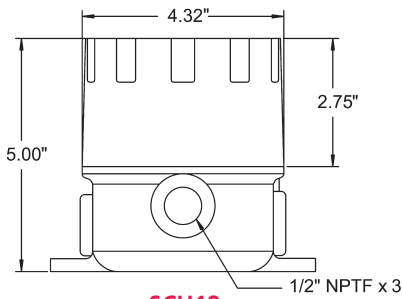

SCH15

STAINLESS STEEL HOUSING

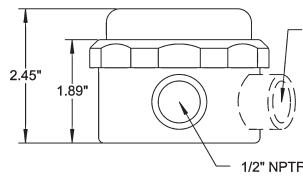

HOUSING for DM700 I LOOP POWERED LED INDICATOR

ABS NEMA 4X HOUSINGS

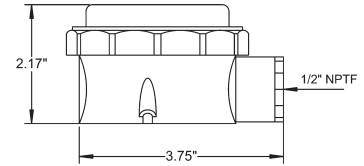

SCH4/A

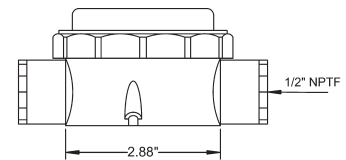

SCH4/B

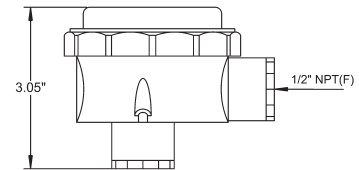

SCH4/C

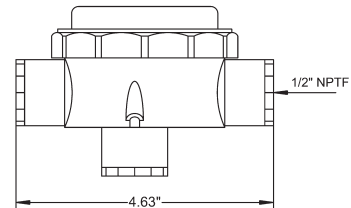

SCH4/D

ORDER CODES:

DM700 I FIELD MOUNTED LOOP POWERED LED INDICATOR

DM700 / **I** / **Housing**

Blank – General Purpose
X – Intrinsically Safe
(ATEX Approved)

SCH4/A-D – NEMA 4X, IP67
SCH15 – Stainless Steel, NEMA 4X, IP67
SCH18 – Aluminum EX FM(3615)

ORDER CODES:

DM720 PANEL MOUNTED LOOP POWERED LED INDICATOR

Local Representation



PO Box 548, 456 Park Ave., Scotch Plains, NJ 07076
Phone: (800) 700-3272 Fax: (800) 700-5468 (US & CA only)
Email: sales@statinst.com Web: www.statinst.com

DM700 I and DM7200/A/3.08